

# CVI321X3



|                               |                          |
|-------------------------------|--------------------------|
| <b>Produktfamilie</b>         | Weinlagerschrank         |
| <b>Installation</b>           | Einbaugerät              |
| <b>Nischenhöhe in cm</b>      | 45 cm                    |
| <b>Abtausystem</b>            | Automatisch              |
| <b>Kühlsystem</b>             | Dynamische Umluftkühlung |
| <b>Scharniersystem</b>        | Standard                 |
| <b>Türanschlag</b>            | Rechts                   |
| <b>Türanschlag reversibel</b> | Ja                       |



## Eigenschaften Weinlagerfach



|   |            |
|---|------------|
| <b>Anzahl der geprägten Flaschenablagen</b>   | 1          |
| <b>Anzahl der variablen Flaschenablagen</b>   | 2          |
| <b>Material der variablen Flaschenablagen</b> | Eichenholz |
| <b>Flaschenablagen auf Telekopauszügen</b>    | Ja         |
| <b>Innenbeleuchtung</b>                       | LED        |
| <b>Innenraumluftfilter</b>                    | Aktivkohle |

## Programme / Funktionen



|                                |                                    |                                     |                   |
|--------------------------------|------------------------------------|-------------------------------------|-------------------|
| <b>Art der Bedienung</b>       | Touch-Control                      | <b>Tastensperre/Kindersicherung</b> | Ja                |
| <b>Position der Bedienung</b>  | Intern im Weinlagerfach            | <b>LED-Innenbeleuchtung</b>         | Variabel regelbar |
| <b>Ausführung des Displays</b> | LED                                | <b>Dynamische Umluftkühlung</b>     | Ja                |
| <b>Displayanzeige</b>          | Temperaturalarm, Temperaturanzeige | <b>Temperaturalarm</b>              | Ja                |
| <b>Funktionsanzeige</b>        | Ja                                 | <b>Türalarm</b>                     | Ja                |

## Technische Eigenschaften

|                                  |   |                                |                     |
|----------------------------------|---|--------------------------------|---------------------|
| <b>Regelbare Temperaturzonen</b> | 1 | <b>Anzahl der Kompressoren</b> | 1                   |
| <b>Unabhängige Kühlsysteme</b>   | 1 | <b>Kompressor</b>              | Vibrationsreduziert |
|                                  |   | <b>Kältemittel</b>             | R600a               |

|                                      |               |                             |             |
|--------------------------------------|---------------|-----------------------------|-------------|
| Anzahl der Türgverglasungen          | 2             | Füllmenge des Kältemittels  | 20 g        |
| Temperaturregelbereich               | +5 bis +20 °C | Material der Isolierung     | Cyclopentan |
| Temperatursteuerung                  | Elektronisch  | Material der Geräterückwand | Metall      |
| UV-Licht geschützte Doppelverglasung | Ja            |                             |             |
| Abtauheizung                         | Ja            |                             |             |

## Technische Daten / Energielabel - ab 1.3.2021









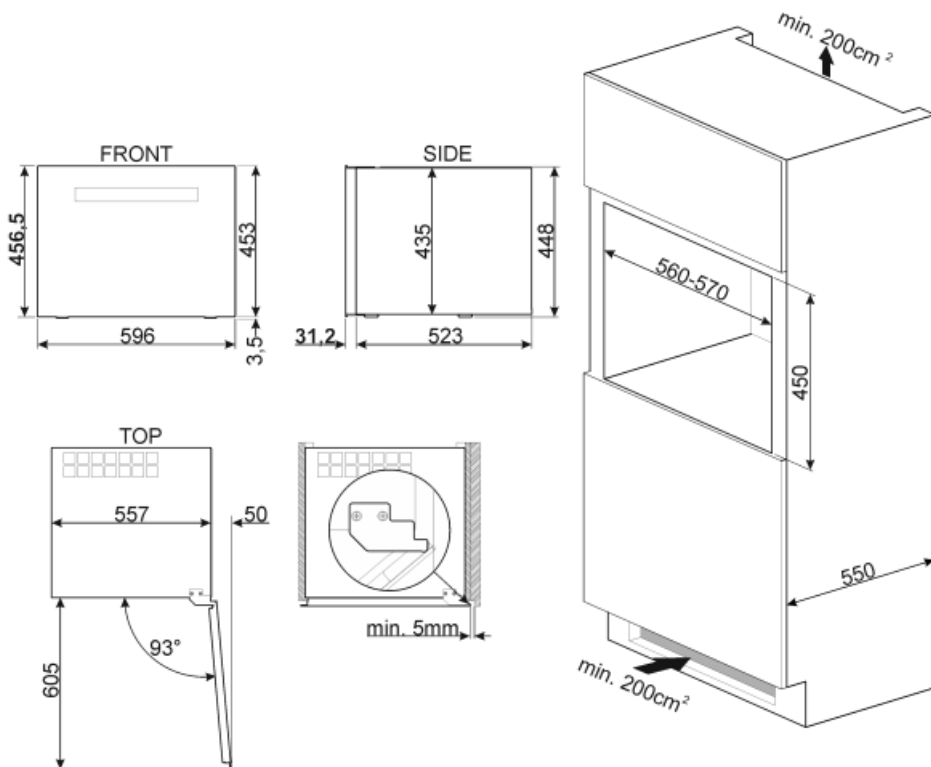

|                             |              |  |           |
|-----------------------------|--------------|--|-----------|
| Jährlicher Energieverbrauch | 100 kWh/Jahr | Summe der Rauminhalte der Kaltlagerfächer und der Kühlfächer | 56 l      |
| Energieeffizienzklasse      | F            | Klimaklassen   | SN, N, ST |
| Luftschallemissionsklasse   | C            | EI   | 124 %     |
| Nutzzinhalt total           | 56 l         |  |           |

## Elektrischer Anschluss

|                                  |              |                      |           |
|----------------------------------|--------------|----------------------|-----------|
| Netzstecker                      | (F;E) Schuko | Spannung             | 220-240 V |
| Elektrischer Gesamtanschlusswert | 40 W         | Frequenz             | 50 Hz     |
| Absicherung                      | 0.4 A        | Länge des Netzkabels | 150 cm    |



## Symbols glossary (TT)

- |  |  |   |  |
|--|--|---|--|
|  | The automatic defrost system works by automatically defrosting at regular intervals eliminating the need to defrost altogether.            |  | LED display: to show programmes, functions and options selected and the time to the end of the cycle.  |
|  | Energy efficiency class F  |  | A+: Energy efficiency class A+ helps to save up to 10% energy compared to class A. Maximum performance with minimum consumption is guaranteed. |
|  | Ventilated: Forced distribution of cold air in the refrigerator compartment, which allows even temperature distribution within the fridge. |  | Fingerprint proof stainless steel: Fingerprint proof stainless steel keeps stainless steel looking as good as new.                             |
|  | LED interior lighting: is a more energy efficient and long lasting way of illuminating the interior of the appliance.                      |  | Nische 45 cm   |
|  | Touch controls: Easy to use touch controls allow the appliance to be programmed at the touch of a button.                                  |   |  |