

# SIM3864D

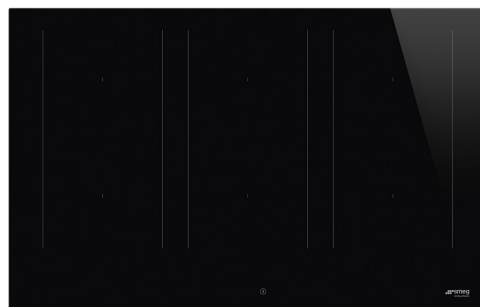

Produktfamilie	Kochfeld
Einbau	C-Schliff, für aufliegende oder flächenbündige Montage
Breite	80 cm
Energiequelle	Strom
Typ der Heiztechnik	Induktion
EAN-Code	8017709305581



## Design



Farbe	Schwarz
Oberfläche	Glas
Design	Neutrales Design
Material	Glas
Glasart	Eclipse Glaskeramik
Typ der Glaskeramik	C-Schliff
Bedienung	Touch-Control, weiß hinterleuchtet
Slider-Bedienung	Ja
Position der Bedienelemente	Frontal
Farbe des Siebdrucks	Grau

## Programme / Funktionen



Anzahl der Kochzonen	6
Anzahl der Induktions-Kochzonen	6
Programmierung der Garzeit	Automatische Abschaltung nach Garzeitende
Anzahl der Kochzonen mit Booster	6
Anzahl der MultiZonen	3
Ein/Aus-Taste	Ja
Leistungsstufen	9
Auto-vent 2.0	Ja

## Optionen



<b>Option MultiZone</b>	Ja	<b>Restzeitanzeige</b>	Ja
<b>Flexible Kochzone</b>	MultiZone	<b>Eco-Logic - Reduzierung der Anschlussleistung</b>	Ja.
<b>Ausschnittmass</b>	490x750-780 mm	<b>Eco-Logic - Reduzierung der Anschlussleistung</b>	2400 a 11100 - step 100 W
<b>Sensor-Warmhalteautomatik</b>	Ja	<b>Demo-Mode Showroom-Funktion</b>	Ja
<b>Sensor Grill-Funktion</b>	Ja	<b>Tastensperre/Kindersicherung Funktion Twinzone</b>	Ja
<b>Timer mit Endabschaltung</b>	6	<b>Schnellstart</b>	Ja
<b>Option Pause</b>	Ja	<b>Schnellauswahl der Leistungsstufen</b>	Ja
<b>Timer/Minutenzähler</b>	1		
<b>Akustisches Signal bei Garzeitende</b>	Ja		

## Technische Eigenschaften



Vorne links - Induktion - MultiZone - 2.10 kW - Booster 2.50 kW - Double booster 3.00 kW - 24.0x18.0 cm  
 Hinten links - Induktion - MultiZone - 2.10 kW - Booster 2.50 kW - Double booster 3.00 kW - 24.0x18.0 cm  
 Vorne Mitte - Induktion - MultiZone - 2.10 kW - Booster 2.50 kW - Double booster 3.00 kW - 24.0x18.0 cm  
 Hinten Mitte - Induktion - MultiZone - 2.10 kW - Booster 2.50 kW - Double booster 3.00 kW - 24.0x18.0 cm  
 Vorne rechts - Induktion - MultiZone - 2.10 kW - Booster 2.50 kW - Double booster 3.00 kW - 24.0x18.0 cm  
 Hinten rechts - Induktion - MultiZone - 2.10 kW - Booster 2.50 kW - Double booster 3.00 kW - 24.0x18.0 cm  
 Multizone left - Booster 3.70 kW - 38.5x23.0 cm  
 Multizone center - Booster 3.70 kW - 38.5x23.0 cm  
 Multizone right - Booster 3.70 kW - 38.5x23.0 cm

<b>Automatische Anpassung des Topfdurchmessers</b>	Ja	<b>Auto-Stop Flüssigkeit-/Überlaufschutz</b>	Ja
<b>Automatische Topferkennung</b>	Ja, min. Ø 9 cm	<b>Restwärmeanzeige</b>	Ja
<b>Automatische Erkennung der Topfposition mit Bedienfeldaktivierung</b>	Ja	<b>Einschaltschutz</b>	Ja
<b>Überhitzungsschutz</b>	Ja		

## Elektrischer Anschluss

<b>Elektrischer Gesamtanschlußwert</b>	11100 W	<b>Typ des Netzkabels</b>	Doppelt universal
<b>Absicherung</b>	49 A	<b>Frequenz</b>	50/60 Hz
<b>Spannung</b>	220-240 V	<b>Länge des Netzkabels</b>	120 cm
<b>Spannung</b>	380-415 V	<b>Anschlussleiste</b>	5-polig

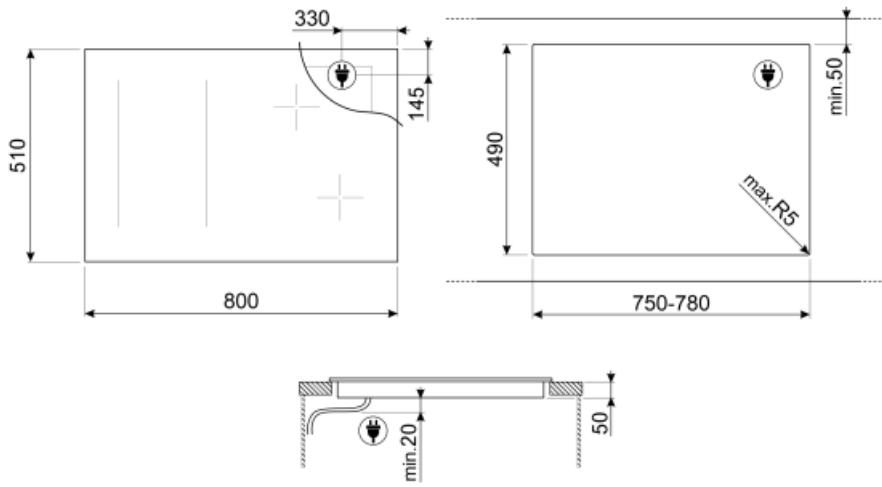

## Sonderzubehör

---

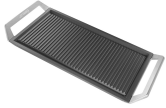

### GRIDDLE

Universal-Barbecue-Grillplatte aus Gusseisen, geeignet für alle BBQ und Kochfelder mit Gas, Glaskeramik und Induktion mit Brückenfunktion (Multizone oder Flexi4Zone), LxB: 517x240 mm



### TPK























Teppanyaki Edelstahl-Grillplatte, Aluminiumkern mit Edelstahlmantelung mit 10 Mal höherer Wärmeleitfähigkeit, geeignet für alle Gas, Glaskeramik und Induktions-Kochfelder



### SCRP

Metall-Glasschaber für alle Glaskeramik-/Induktionskochfelder

## Symbols glossary (TT)

 <p>Power booster: option allows the zone to work at full power when very intense cooking is necessary.</p>	 <p>Kindersicherung: Einige Modelle sind mit einer Tastensperre ausgestattet, die eine versehentliche Änderung des Programms sperrt.</p>
 <p>The slider control panel allows you to adjust the power simply by passing your finger across the touch device.</p>	 <p>This function allows you to keep cooked food warm without burner it</p>
 <p>Overheat protection: The safety system that automatically turns off the hob in case of overheating of the control unit.</p>	 <p>Induction: The work of these hobs is based on the principle of electromagnetic induction. The heat is generated directly in the bottom of the pan during its contact with the hob.</p>
 <p>Multizone: allows several pans to be used at once, large or small, offering freedom of placement and greater flexibility</p>	 <p>Overfill protection: The special overflow protection shuts down the stove in the presence of overflow of liquids.</p>
 <p>All cooking zones can be reduced to the minimum power level, so the hob can be left unattended for a short period without food overcooking or burning. Then just press again this function, the previously set power levels can be reactivated.</p>	 <p>QUICK-SET</p>
 <p>Quick Start function: the chosen temperature is reached faster. The heating element works at maximum power until the right temperature is reached.</p>	 <p>Indication of residual heat: After the glass ceramic hob is switched off the residual heat indicator shows which of the heating zones still remains hot. When the temperature drops below 60 ° C, the indicator goes out.</p>
 <p>Time elapsed: shows how long the cooking zone has been in use.</p>	 <p>Timer: All ceramic hobs have a timer which automatically ends cooking after a preset time.</p>
 <p>TWIN_ZONE_72dpi</p>	 <p>Permanent auto pot detection</p>
 <p>Connection between hob and hood</p>	 <p>Grill function</p>
 <p>Min diameter pot detection of 9 cm</p>	 <p>Possibility to set the maximum power absorption of the hob</p>
 <p>Perfect fit in a 80 cm cabinet</p>	 <p>Darkness becomes light</p>
 <p>Evolution Slider totally Back-lighted ghost effect</p>	